

# BrightLux

LED & SOLAR

2023 CATALOGUE

Indoor

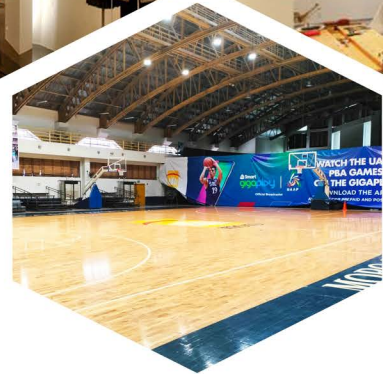

**KASSEL Ventures Phils., Inc.**

Unit 519 5th Floor, CityLand Shaw Tower  
Shaw Blvd., corner St. Francis Street  
Mandaluyong City 1552 Philippines

Tel. Nos.: +632-8633-6610; +632-8470-6669  
Mobile: +63-917-582-2330; +63-939-917-1323  
Email: sales@brightluxled.com.ph  
brightluxledsales@gmail.com  
Website: www.brightlux-led.co

### LED Downlights



Pages 3/4/5/6/7/8/9

### LED Surface Mounted Downlights



Pages 10/11

### LED Grille/Gimble Downlights



Pages 12/13

### LED Track Lights



Page 14

### LED Round Panel Lights



Pages 15/16

### LED Square Panel Lights

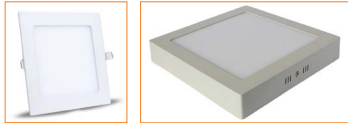

Pages 17/18

### LED Big Panel Lights



Page 19

### LED Tube Lights



Pages 20/21/22

### LED Tri-proof Lights



Page 23

### LED UFO High Bay Lights



Pages 24/25

### LED Canopy Lights



Page 26

Product Pictures:

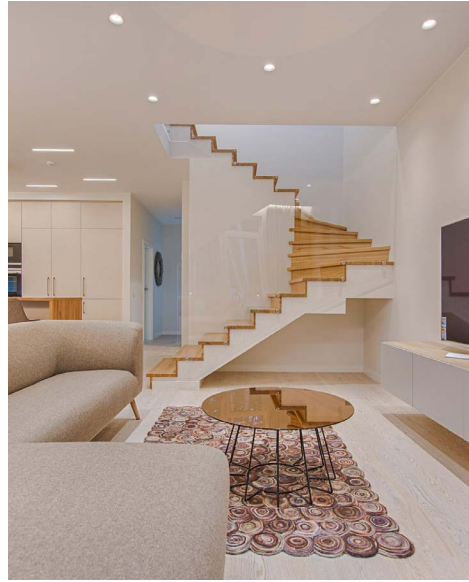

Features:

- Less glare flush type trim
- CITIZEN or CREE COB chip
- Aluminum heatsink for better heat dissipation
- Clear or frosted PC cover
- Lifud, BOKE or Eaglerise external driver
- Can be dimmable

Applications:

- Suitable for task-specific or accent lighting, wall washing
- For installation in flat ceilings hotel guest rooms, corridors, hallways, lobby areas
- Residential living rooms, bedrooms, foyer
- Retail stores display case, counters, fitting rooms, walls and glass window washer
- Department store, supermarket, museum, art gallery etc.

Specifications:

List Price:								
Model:	BPS-DL-5W-C20	BPS-DL-9W-C20	BPS-DL-12W-C20	BPS-DL-20W-C20	BPS-DL-30W-C20	BPS-DL-40W-C20	BPS-DL-50W-C20	
Input Voltage:	AC220-240V / 50~60Hz		AC220-240V / 50~60Hz		AC220-240V / 50~60Hz			
LED Power:	5 Watts	9 Watts	12 Watts	20Watts	30 Watts	40 Watts	50 Watts	
Luminous Efficiency:	100-110Lm/W		100-110Lm/W		100-110Lm/W			
Luminous Flux:	500-550Lm	900-990Lm	1080-1200Lm	2000-2200Lm	3000-3300Lm	4000-4400Lm	5000-5500Lm	
CCT:	3000K/4000K/5000K		3000K/4000K/5000K		3000K/4000K/5000K			
CRI:	Ra>80		Ra>80		Ra>80			
Beam Angle:	15° / 24° / 36° (Optional)		24° / 40° / 60° (Optional)		24° / 40° / 60° (Optional)			
IP Rating:	IP20		IP20		IP20			
Dimension:	D=95mm * H=63mm	D=95mm * H=63mm	D=115mm * H=116mm	D=142mm * H=102mm	D=160mm * H=133mm	D=160mm * H=133mm	D=185mm * H=156mm	
Ceiling Cut-out:	Φ=75mm	Φ=75mm	Φ=95mm	Φ=125mm	Φ=140mm	Φ=140mm	Φ=160mm	

Dimension Diagram:

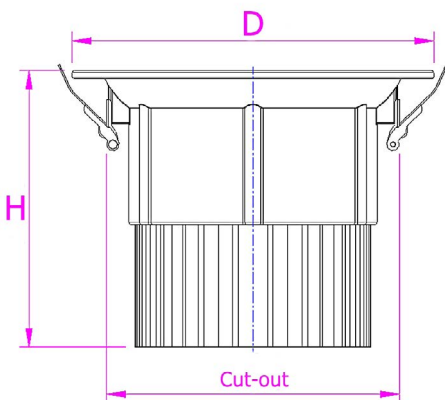

LED Chips:



Driver:



Trim Color:



Photometric Diagram:

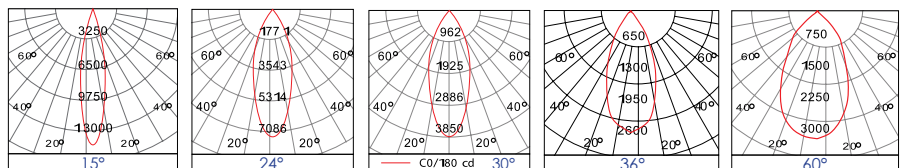

Product Pictures:



Features:

- Less glare flush type trim
- CITIZEN LED COB chip
- Aluminum heatsink for better heat dissipation
- PC cover lens
- Lifud or Eaglerise external driver
- Can be dimmable

Applications:

- Suitable for task-specific or accent lighting, wall washing
- For installation in flat ceilings hotel guest rooms, corridors, hallways, lobby areas
- Residential living rooms, bedrooms, foyer.
- Retail stores display case, counters, fitting rooms, walls and glass window washer
- Department store, supermarket, museum, art gallery etc.

Specifications:

List Price:						
Model:	BPS-DL-7W-C8	BPS-DL-12W-C8	BPS-DL-15W-C8	BPS-DL-20W-C8	BPS-DL-30W-C8	
Input Voltage:	AC220-240V / 50~60Hz			AC220-240V / 50~60Hz		AC220-240V / 50~60Hz
LED Power:	7 Watts	12 Watts	15 Watts	20 Watts	30 Watts	
Luminous Efficacy:	100-110Lm/W			100-110Lm/W		100-110Lm/W
Luminous Flux:	700-770Lm	1200-1320Lm	1500-1650Lm	2000-2200Lm	3000-3300Lm	
CCT:	3000K/4000K/5000K			3000K/4000K/5000K		3000K/4000K/5000K
CRI:	Ra>80			Ra>80		Ra>80
Beam Angle:	90°			90°		90°
IP Rating:	IP44			IP44		IP44
Dimension:	D=115mm * H=48mm	D=145mm * H=54mm	D=160mm * H=60mm	D=190mm * H=60mm	D=230mm * H=75mm	
Ceiling Cut-out:	Φ=100mm	Φ=130mm	Φ=145mm	Φ=170mm	Φ=205mm	

Dimension Diagram:

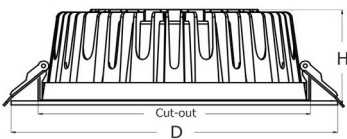

LED Chips:



Driver:



Trim Color:



Photometric Diagram:

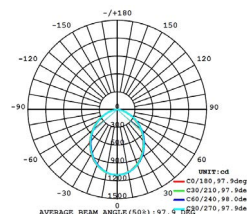



Product Pictures:



Features:

- Less glare flush type trim
- CITIZEN or CREE COB chip
- Aluminum heatsink for better heat dissipation
- Clear or frosted PC cover
- Lifud, BOKE or Eaglerise external driver
- Can be dimmable

Applications:

- Suitable for task-specific or accent lighting, wall washing
- For installation in flat ceilings hotel guest rooms, corridors, hallways, lobby areas
- Residential living rooms, bedrooms, foyer
- Retail stores display case, counters, fitting rooms, walls and glass window washer
- Department store, supermarket, museum, art gallery etc.

Specifications:

List Price:					
Model:	BPS-DL-10W-C18	BPS-DL-15W-C18	BPS-DL-20W-C18	BPS-DL-30W-C18	BPS-DL-40W-C18
Input Voltage:	AC220-240V / 50-60Hz		AC220-240V / 50-60Hz		AC220-240V / 50-60Hz
LED Power:	10 Watts	15 Watts	20 Watts	30 Watts	40 Watts
Luminous Efficacy:	100-110Lm/W		100-110Lm/W		100-110Lm/W
Luminous Flux:	1000-1100Lm	1500-1650Lm	2000-2200Lm	3000-3300Lm	4000-4400Lm
CCT:	3000K/4000K/5000K		3000K/4000K/5000K		3000K/4000K/5000K
CRI:	Ra>80		Ra>80		Ra>80
Beam Angle:	15° / 24° / 38° (Optional)		24° / 38° / 60° (Optional)		24° / 38° / 60° (Optional)
IP Rating:	IP20		IP20		IP20
Dimension:	D=86mm * H=55mm	D=101mm * H=60mm	D=140mm * H=73mm	D=180mm * H=94mm	D=214mm * H=110mm
Ceiling Cut-out:	Φ=75mm	Φ=90mm	Φ=125mm	Φ=165mm	Φ=200mm

Dimension Diagram:

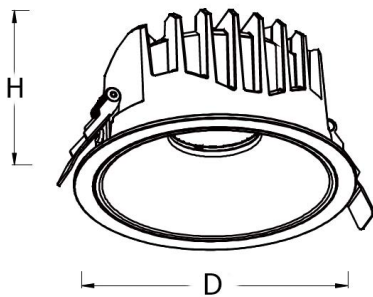

LED Chips:



Driver:



Trim Color:



Photometric Diagram:

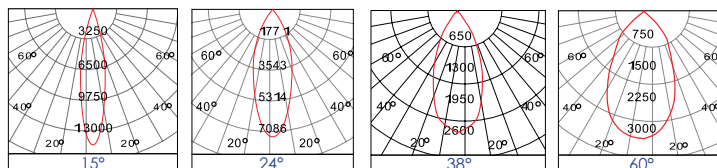

Product Pictures:



Features:

- Directional/Tilttable light head
- CITIZEN or LUMINUS COB Chip
- LIFUD / BOKE / Eaglerise driver
- Frosted or clear PC cover
- Easy to install featuring torsion spring lock.
- External driver
- Can be dimmable

Applications:

- Suitable for task-specific lighting, accent lighting, wall washing
- For installation in flat or sloped ceilings
- Hotel guest rooms, corridors, hallways, lobby areas
- Residential living rooms, bedrooms, foyer
- Retail stores display case, counters, fitting rooms, walls and glass window washer
- Department store, supermarket, museum, art gallery etc.

Specifications:

List Price:					
Model:	BPS-DL-9W-C10	BPS-DL-12W-C10	BPS-DL-15W-C10	BPS-DL-20W-C10	BPS-DL-30W-C10
Input Voltage:	AC220-240V / 50~60Hz			AC220-240V / 50~60Hz	
LED Power:	9 Watts	12 Watts	15 Watts	20 Watts	30 Watts
Luminous Efficacy:	90-100Lm/W		90-100Lm/W		90-100Lm/W
Luminous Flux:	810-900Lm	1080-1200Lm	1350-1500Lm	1800-2000Lm	2700-3000Lm
CCT:	2700K-5000K		2700K-5000K		2700K-5000K
CRI:	Ra>80		Ra>80		Ra>80
Beam Angle:	15° / 24° / 38°		15° / 24° / 38°		15° / 24° / 38°
IP Rating:	IP20		IP20		IP20
Dimension:	D=85mm * H=80mm	D=85mm * H=80mm	D=104mm * H=108mm	D=132mm * H=127mm	D=132mm * H=127mm
Cut-out:	Φ=75mm	Φ=75mm	Φ=95mm	Φ=125mm	Φ=125mm

Dimension Diagram:

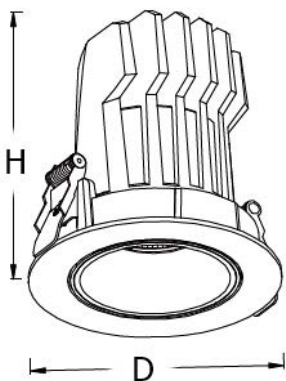

LED Chips:



Driver:



Trim Color:



Photometric Diagram:

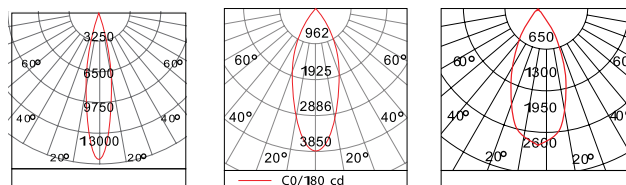

Product Pictures:



Features:

- Directional/Tiltable light head
- CREE or CITIZEN COB Chip
- LIFUD / BOKE / Eaglerise driver
- Frosted or clear PC cover
- Easy to install featuring torsion spring lock
- External driver
- Can be dimmable

Applications:

- Suitable for task-specific lighting, accent lighting, wall washing
- For installation in flat or sloped ceilings
- Hotel guest rooms, corridors, hallways, lobby areas
- Residential living rooms, bedrooms, foyer
- Retail stores display case, counters, fitting rooms, walls and glass window washer
- Department store, supermarket, museum, art gallery etc.

Specifications:

List Price:								
Model:	BPS-DL-7W-C3	BPS-DL-12W-C3	BPS-DL-15W-C3	BPS-DL-20W-C3	BPS-DL-30W-C3	BPS-DL-40W-C3	BPS-DL-50W-C3	
Input Voltage:	AC220-240V / 50-60Hz		AC220-240V / 50-60Hz		AC220-240V / 50-60Hz			
LED Power:	7 Watts	12 Watts	15 Watts	20 Watts	30 Watts	40 Watts	50 Watts	
Luminous Efficiency:	90-100lm/W		100-110lm/W		100-110lm/W			
Luminous Flux:	630-700lm	1080-1200lm	1500-1650lm	2000-2200lm	3000-3300lm	4000-4400lm	5000-5500lm	
CCT:	2700K-5000K		2700K-5000K		2700K-5000K			
CRI:	Ra>80		Ra>80		Ra>80			
Beam Angle:	30°		24° / 36° / 60°		24° / 36° / 60°			
IP Rating:	IP20		IP20		IP20			
Dimension:	D=95mm * H=59mm	D=95mm * H=81mm	D=119mm * H=103mm	D=142mm * H=118mm	D=142mm * H=118mm	D=180mm * H=130mm	D=180mm * H=150mm	
Cut-out:	Φ=70mm	Φ=70mm	Φ=90mm	Φ=110mm	Φ=110mm	Φ=145mm	Φ=145mm	

Dimension Diagram:

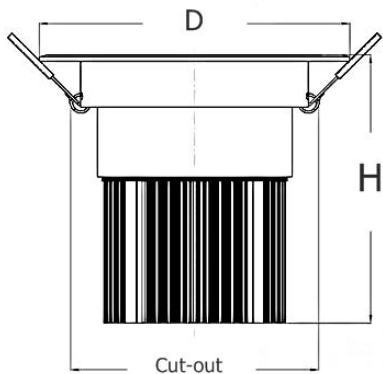

LED Chips:



Driver:



Trim Color:



Photometric Diagram:

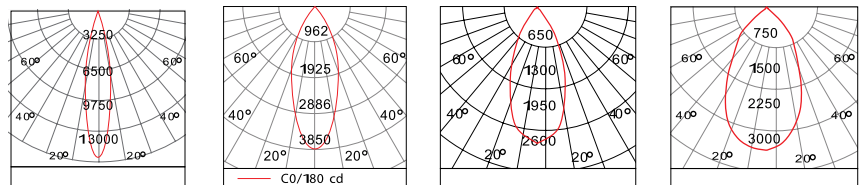

Product Pictures:



Features:

- Design for Hotels
- CITIZEN or LUMINUS Chip
- TRIDONIC or BOKE Driver
- Various aperture options for precision lighting
- Pinhole options, wide, spot, square and elliptical.
- Easy to install featuring sturdy torsion spring lock
- White or black powder coated trim

Applications:

- Suitable for task-specific or accent lighting, wall washing
- For installation in flat or sloped ceilings
- For Hotel guest rooms, corridors, hallways, lobby areas etc.

Specifications:

List Price:	FIXED ADJUSTABLE			
Model:	BPS-DL-7W-C24-F/A	BPS-DL-12W-C24-F/A	BPS-DL-15W-C24-F/A	BPS-DL-18W-C24-F/A
Input Voltage:	AC220-240V / 50~60Hz		AC220-240V / 50~60Hz	
LED Power:	7 Watts	12 Watts	15 Watts	18 Watts
Luminous Efficacy:	80-90Lm/W	80-90Lm/W	80-90Lm/W	80-90Lm/W
Luminous Flux:	560-630Lm	960-1080Lm	1200-1350Lm	1440-1620Lm
CCT:	3000K/4000K/5000K	3000K/4000K/5000K	3000K/4000K/5000K	3000K/4000K/5000K
CRI:	Ra 80-90	Ra 80-90	Ra 80-90	Ra 80-90
Beam Angle:	15° / 24° / 36° (optional)	15° / 24° / 36° (optional)	15° / 24° / 36° (optional)	15° / 24° / 36° (optional)
IP Rating:	IP20	IP20	IP20	IP20
Dimension:	D=85mm * H=95mm	D=85mm * H=95mm	D=95mm * H=117mm	D=95mm * H=117mm
Cut-out:	Φ=75mm	Φ=75mm	Φ=85mm	Φ=85mm

Dimension Diagram:

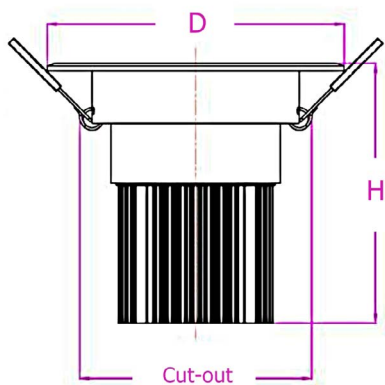

LED Chips:



Driver:



Trim Color:



Photometric Diagram:

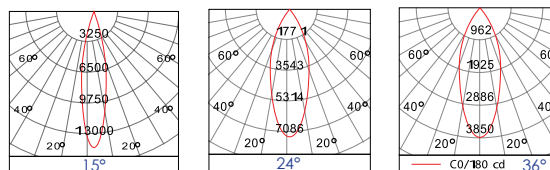



Product Pictures:



Features:

- Less glare flush type trim
- CITIZEN COB chip
- Aluminum heatsink for better heat dissipation
- Clear or frosted PC cover
- BOKE or DONE external led driver
- Can be dimmable

Applications:

- Suitable for accent or general lighting, wall washing
- For installation in flat ceilings hotel guest rooms, corridors, hallways, lobby areas
- Residential living rooms, bedrooms, foyer
- Retail stores display case, counters, fitting rooms, walls and glass window washer
- Department store, supermarket, museum, art gallery etc.

Specifications:

List Price:						
Model:	BPS-DL-12W-C16	BPS-DL-15W-C16	BPS-DL-20W-C16	BPS-DL-30W-C16	BPS-DL-40W-C16	BPS-DL-50W-C16
Input Voltage:	AC220-240V / 50-60Hz		AC220-240V / 50-60Hz		AC220-240V / 50-60Hz	
LED Power:	12 Watts	15 Watts	20 Watts	30 Watts	40 Watts	50 Watts
Luminous Efficacy:	100-110Lm/W		100-110Lm/W		100-110Lm/W	
Luminous Flux:	1200-1320Lm	1500-1650Lm	2000-2200Lm	3000-3300Lm	4000-4400Lm	5000-5500Lm
CCT:	3000K/4000K/5000K		3000K/4000K/5000K		3000K/4000K/5000K	
CRI:	Ra>80		Ra>80		Ra>80	
Beam Angle:	60°		60°		60°	
IP Rating:	IP20		IP20		IP20	
Dimension:	D=110mm * H=53mm	D=145mm * H=69mm	D=145mm * H=69mm	D=190mm * H=86mm	D=230mm * H=99mm	D=230mm * H=99mm
Ceiling Cut-out:	Φ=95mm	Φ=125mm	Φ=125mm	Φ=165mm	Φ=200mm	Φ=200mm

Dimension Diagram:

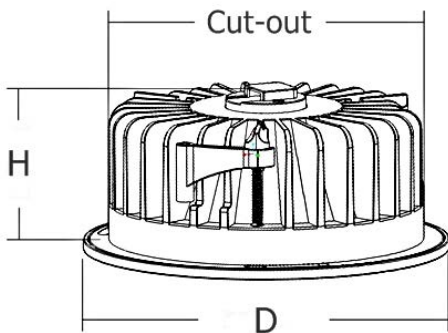

LED Chips:



Driver:



Trim Color:



Photometric Diagram:

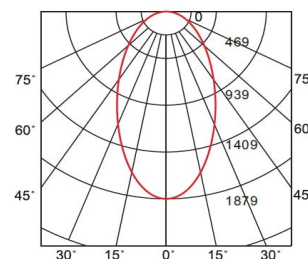

Product Pictures:



Features:

- Surface mounted fixture
- CITIZEN or LUMINUS COB Chip
- LIFUD / BOKE / Eaglerise driver
- Frosted or clear PC cover
- Easy to install
- Internal driver
- Can be dimmable

Applications:

- Surface mounted or pendant fixture
- Use as an alternative to recessed lighting
- Suitable for indoor use only

Specifications:

List Price:					
Model:	BPS-SDL-12W-RO	BPS-SDL-15W-RO	BPS-SDL-20W-RO	BPS-SDL-25W-RO	BPS-SDL-30W-RO
Input Voltage:	AC220-240V / 50~60Hz			AC220-240V / 50~60Hz	
LED Power:	12 Watts	15 Watts	20 Watts	25 Watts	30 Watts
Luminous Efficacy:	90-100Lm/W			90-100Lm/W	
Luminous Flux:	1080-1200Lm	1350-1500Lm	1800-2000Lm	2250-2500Lm	2700-3000Lm
CCT:	2800K-5000K			2800K-5000K	
CRI:	Ra>80			Ra>80	
Beam Angle:	24° / 38° / 60°			24° / 38° / 60°	
IP Rating:	IP20			IP20	
Dimension:	D=74mm * H=147mm	D=110mm * H=120mm	D=130mm * H=152mm	D=170mm * H=185mm	D=193mm * H=193mm
Cut-out:	N/A	N/A	N/A	N/A	N/A

Dimension Diagram:

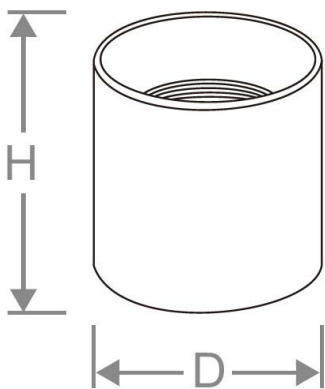

LED Chips:



Driver:



Housing Color:



Photometric Diagram:

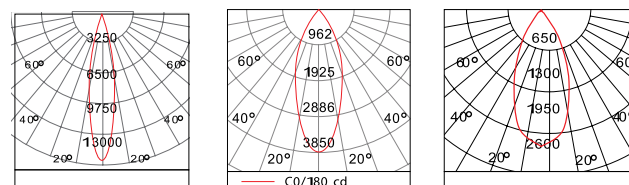

Product Pictures:



Features:

- Surface mounted fixture
- CITIZEN COB Chip
- LIFUD / BOKE / Eaglerise driver
- Frosted or clear PC cover
- Easy to install
- Internal driver
- Can be dimmable

Applications:

- Surface mounted fixture
- Use as an alternative to recessed lighting
- Suitable for indoor use only

Specifications:

List Price:			
Model:	BPS-SDL-2X15W-GRDL	BPS-SDL-2X20W-GRDL	BPS-SDL-2X30W-GRDL
Input Voltage:	AC220-240V / 50-60Hz		AC220-240V / 50-60Hz
LED Power:	30 Watts	40 Watts	60 Watts
Luminous Efficacy:	90-100lm/W	90-100lm/W	90-100lm/W
Luminous Flux:	2700-3000Lm	3600-4000Lm	5400-6000Lm
CCT:	2800K-5000K	2800K-5000K	2800K-5000K
CRI:	Ra>80	Ra>80	Ra>80
Beam Angle:	15° / 24° / 38° / 60°	15° / 24° / 38° / 60°	15° / 24° / 38° / 60°
IP Rating:	IP20	IP20	IP20
Dimension:	L=300mm * W=150mm * H=180mm	L=300mm * W=150mm * H=180mm	L=300mm * W=150mm * H=180mm
Cut-out:	N/A	N/A	N/A

Dimension Diagram:



LED Chips:  
CITIZEN

Driver:  
LIFUD E•XE  
DONE

Trim Color:  
 White  Black  Grey

Photometric Diagram:

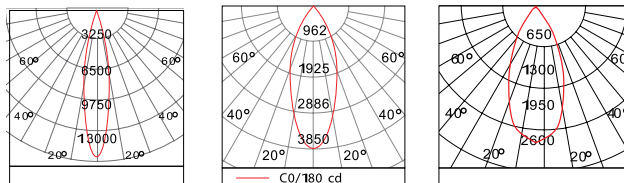

Product Pictures:



Features:

- Fully adjustable lamp head
- CITIZEN COB chip
- BOKE or LIFUD driver
- High quality aluminum heatsink for better heat dissipation
- Glareless glass or PC cover
- Can be dimmable

Applications:

- Suitable for specific lighting, accent lighting, wall washing etc.
- Residential and commercial lighting
- Department store and Supermarket, Museum, Art Gallery, Malls, Boutiques, Offices, Conference rooms etc.

Specifications:

List Price:						
Product Type:	Single Head			Double Head		
Model:	BPS-GRDL-12W	BPS-GRDL-20W	BPS-GRDL-30W	BPS-GRDL-24W-2X12W	BPS-GRDL-40W-2X20W	BPS-GRDL-60W-2X30W
Input Voltage:	AC220-240V / 50~60Hz			AC220-240V / 50~60Hz		
LED Power:	12 Watts	20 Watts	30 Watts	24 Watts	40 Watts	60 Watts
Luminous Efficacy:	90-100lm/W			90-100lm/W		
Luminous Flux:	1080-1200lm	1800-2000lm	2700-3000lm	2160-2400lm	3600-4000lm	5400-6000lm
CCT:	3000K / 4000K / 5000K			3000K / 4000K / 5000K		
CRI:	Ra>80			Ra>80		
Beam Angle:	15° / 24° / 36° / 60° (Optional)			15° / 24° / 36° / 60° (Optional)		
IP Rating:	IP20			IP20		
Dimension:	L=185mm * W=185mm * H=165mm			L=375mm * W=185mm * H=165mm		
Cut-out:	L=165mm * W=165mm			L=350mm * W=165mm		

Dimension Diagram:

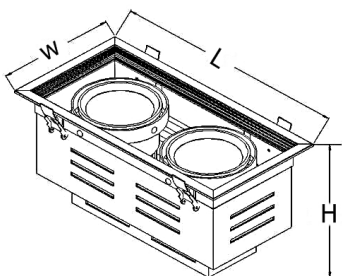
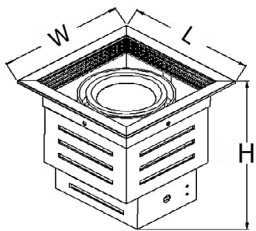

LED Chips:  
**CITIZEN**

Driver:  
CE **RoHS**  
**MOX** **DONE**

Housing/Trim Color:  
 White  Black  Grey

Photometric Diagram:

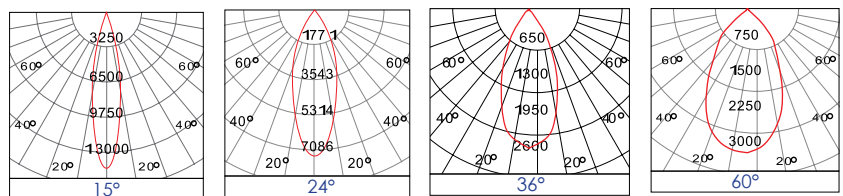



Product Pictures:



Features:

- Fully adjustable lamp head
- CITIZEN COB chip
- BOKE or LIFUD driver
- High quality aluminum heatsink for better heat dissipation
- Glareless glass or PC cover
- Can be dimmable

Applications:

- Suitable for specific lighting, accent lighting, wall washing etc.
- Residential and commercial lighting
- Department store and Supermarket, Museum, Art Gallery, Malls, Boutiques, Offices, Conference rooms etc.

Specifications:

List Price:			
Product:	Triple Head		
Model:	BPS-GRDL-36W-3X12W	BPS-GRDL-60W-3X20W	BPS-GRDL-90W-3X30W
Input Voltage:	AC220-240V / 50-60Hz		
LED Power:	36 Watts	60 Watts	90 Watts
Luminous Efficacy:	90-100Lm/W		
Luminous Flux:	3240-3600Lm	5400-6000Lm	8100-9000Lm
CCT:	3000K / 4000K / 5000K		
CRI:	Ra>80		
Beam Angle:	15° / 24° / 36° / 60° (Optional)		
IP Rating:	IP20		
Dimension:	L=500mm * W=185mm * H=165mm		
Cut-out:	L=480mm * W=165mm		

Dimension Diagram:

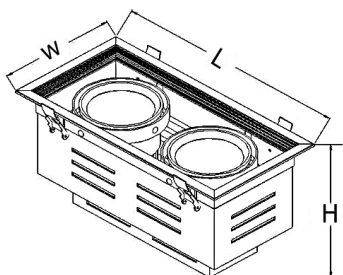

LED Chips:

**CITIZEN**

Driver:

CE **RoHS**  
**BOKE DONE**

Housing/Trim Color:

White  Black  Grey

Photometric Diagram:

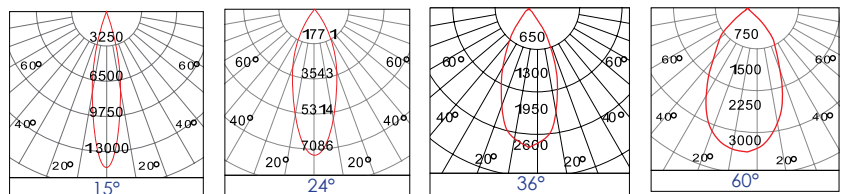

Product Pictures:



Features:

- Fully adjustable, pull-out and rotate 355 degree
- CITIZEN LED COB chip
- BOKE or DONE LED driver
- High quality aluminum heatsink for better heat dissipation
- Glareless glass or PC cover
- Can be dimmable

Applications:

- Suitable for specific lighting, accent lighting, wall washing etc.
- Residential and commercial lighting
- Department store and Supermarket, Museum, Art Gallery, Malls, Boutiques, Offices, Conference rooms etc.

Specifications:

List Price:						
Model:	BPS-TL-10W-X16B	BPS-TL-15W-X16B	BPS-TL-20W-X16B	BPS-TL-30W-X16B	BPS-TL-40W-X16B	BPS-TL-50W-X16B
Input Voltage:	AC220-240V / 50~60Hz			AC220-240V / 50~60Hz		
LED Power:	10 Watts	15Watts	20 Watts	30 Watts	40 Watts	50 Watts
Luminous Efficacy:	90-100Lm/W			90-100Lm/W		
Luminous Flux:	900-1000Lm	1350-1500Lm	1800-2000Lm	2700-3000Lm	3600-4000Lm	4500-5000Lm
CCT:	3000K / 4000K / 5000K			3000K / 4000K / 5000K		
CRI:	Ra>80 / RA>90			Ra>80 / RA>90		
Beam Angle:	15° / 24° / 38° / 60° (Optional)			15° / 24° / 38°		24° / 38°
IP Rating:	IP20			IP20		
Dimension:	D=60mm * L=190mm H=140mm		D=80mm * L=210mm H=180mm	D=90mm * L=210mm H=190mm	D=95mm * L=200mm H=185mm	D=99mm * L=210mm H=160mm

Dimension Diagram:

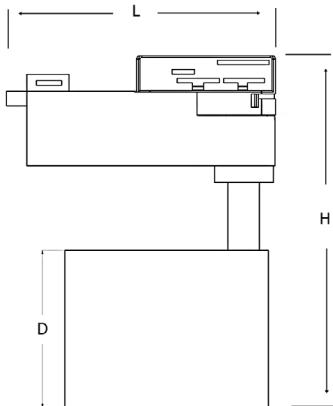

LED Chips:  
**CITIZEN**

Driver:  
CE **RoHS**  
**BOKE DONE**

Housing/Trim Color:  
 White  Black  Grey

Photometric Diagram:

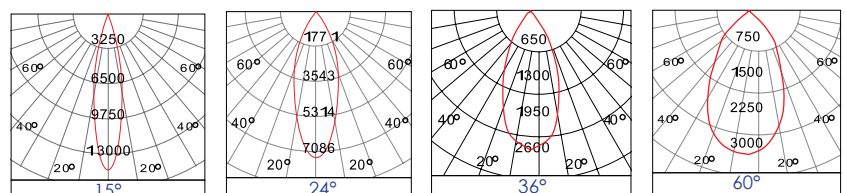

Product Pictures:



Features:

- Recessed mounted, thin fixture
- EPISTAR LED chip
- CE approved external driver
- Aluminum heatsink for better heat dissipation
- Frosted PMMA LGP+PS diffuser
- Can be dimmable and CCT tunable (Optional)

Applications:

- Suitable for ambient or general lighting
- Commercial or Residential use
- Offices, call center, conference room, schools, banks, restaurants etc.

Specifications:

List Price:						
Model:	BWE-PL-4W-RO-R	BWE-PL-6W-RO-R	BWE-PL-9W-RO-R	BWE-PL-12W-RO-R	BWE-PL-18W-RO-R	BWE-PL-24W-RO-R
Input Voltage:	AC100-240V / 50-60Hz		AC100-240V / 50-60Hz		AC100-240V / 50-60Hz	
LED Power:	4 Watts	6 Watts	9 Watts	12Watts	18 Watts	24 Watts
Luminous Efficacy:	70-80lm/W		70-80lm/W		70-80lm/W	
Luminous Flux:	280-320lm	420-480lm	630-720lm	840-960lm	1260-1440lm	1680-1920lm
CCT:	3000K / 4000K / 5000K / 6000K		3000K / 4000K / 5000K / 6000K		3000K / 4000K / 5000K / 6000K	
CRI:	Ra>80		Ra>80		Ra>80	
Beam Angle:	120°		120°		120°	
IP Rating:	IP20		IP20		IP20	
Dimension:	D=105mm * H=12mm	D=120mm * H=12mm	D=145mm * H=12mm	D=170mm * H=12mm	D=225mm * H=12mm	D=300mm * H=12mm
Ceiling Cut-out:	Φ=95mm	Φ=105mm	Φ=125mm	Φ=150mm	Φ=200mm	Φ=275mm

Dimension Diagram:

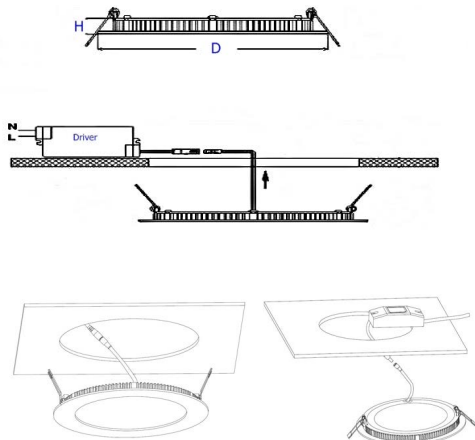

LED Chips:  
**EPISTAR**

Driver:  
**CE RoHS**

Trim Color:  
 White  
  Black  
  Grey

Photometric Diagram:

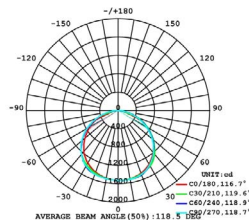

Product Pictures:



Features:

- Recessed mounted, thin fixture
- EPISTAR LED chip
- Lifud or CE approved external driver
- Aluminum heatsink for better heat dissipation
- Frosted PMMA LGP+PS diffuser
- Can be dimmable and CCT tunable (Optional)

Applications:

- Suitable for ambient or general lighting
- Commercial or Residential use
- Offices, call center, conference room, schools, banks, restaurants etc.

Specifications:

List Price:				
Model:	BWE-PL-6W-RO-S	BWE-PL-12W-RO-S	BWE-PL-18W-RO-S	BWE-PL-24W-RO-S
Input Voltage:	AC100-240V / 50-60Hz		AC100-240V / 50-60Hz	
LED Power:	6 Watts	12 Watts	18 Watts	24 Watts
Luminous Efficacy:	70-80lm/W		70-80lm/W	
Luminous Flux:	420-480lm	840-960lm	1260-1440lm	1680-1920lm
CCT:	3000K / 4000K / 5000K / 6000K		3000K / 4000K / 5000K / 6000K	
CRI:	Ra>80		Ra>80	
Beam Angle:	120°		120°	
IP Rating:	IP20		IP20	
Dimension:	D=120mm * H=38mm	D=170mm * H=38mm	D=225mm * H=38mm	D=300mm * H=38mm
Ceiling Cut-out:	N/A	N/A	N/A	N/A

Dimension Diagram:

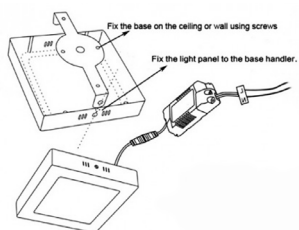

LED Chips:  
**EPISTAR**

Driver:  
CE **RoHS**  
**Lifud**

Trim Color:  
 White  Black  Grey

Photometric Diagram:

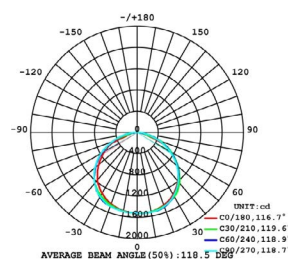



Product Pictures:



Features:

- Recessed mounted, thin fixture
- EPISTAR LED chip
- Lifud or CE approved external driver
- Aluminum heatsink for better heat dissipation
- Frosted PMMA LGP+PS diffuser
- Can be dimmable and CCT tunable (Optional)

Applications:

- Suitable for ambient or general lighting
- Commercial or Residential use
- Offices, call center, conference room, schools, banks, restaurants etc.

Specifications:

List Price:						
Model:	BWE-PL-4W-SQ-R	BWE-PL-6W-SQ-R	BWE-PL-9W-SQ-R	BWE-PL-12W-SQ-R	BWE-PL-18W-SQ-R	BWE-PL-24W-SQ-R
Input Voltage:	AC100-240V / 50-60Hz		AC100-240V / 50-60Hz		AC100-240V / 50-60Hz	
LED Power:	4 Watts	6 Watts	9 Watts	12Watts	18 Watts	24 Watts
Luminous Efficacy:	70-80lm/W		70-80lm/W		70-80lm/W	
Luminous Flux:	280-320lm	420-480lm	630-720lm	840-960lm	1260-1440lm	1680-1920lm
CCT:	3000K / 4000K / 5000K / 6000K		3000K / 4000K / 5000K / 6000K		3000K / 4000K / 5000K / 6000K	
CRI:	Ra>80		Ra>80		Ra>80	
Beam Angle:	120°		120°		120°	
IP Rating:	IP20		IP20		IP20	
Dimension:	L=105mm * W=105mm * H=12mm	L=120mm * W=120mm * H=12mm	L=145mm *W=145mm * H=12mm	L=170mm *W=170mm * H=12mm	L=225mm *W=225mm * H=12mm	L=300mm * W=300mm * H=12mm
Ceiling Cut-out:	L=95mm * W=95mm	L=105mm * W=105mm	L=125mm * W=125mm	L=150mm * W=150mm	L=200mm * W=200mm	L=275mm * W=275mm

Dimension Diagram:

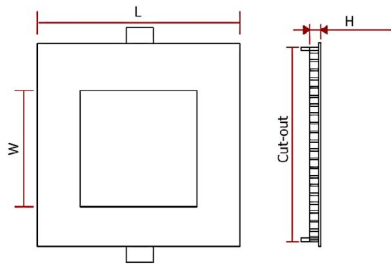

LED Chips:  
**EPISTAR**

Driver:  
**CE RoHS**  
**LIFUD**

Trim Color:  
 White  Black  Grey

Photometric Diagram:

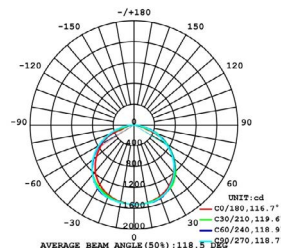

Product Pictures:



Features:

- Recessed mounted, thin fixture
- EPISTAR LED chip
- Lifud or CE approved external driver
- Aluminum heatsink for better heat dissipation
- Frosted PMMA LGP+PS diffuser
- Can be dimmable and CCT tunable (Optional)

Applications:

- Suitable for ambient or general lighting
- Commercial or Residential use
- Offices, call center, conference room, schools, banks, restaurants etc.

Specifications:

List Price:				
Model:	BWE-PL-6W-SQ-S	BWE-PL-12W-SQ-S	BWE-PL-18W-SQ-S	BWE-PL-24W-SQ-S
Input Voltage:	AC100-240V / 50-60Hz		AC100-240V / 50-60Hz	
LED Power:	6 Watts	12 Watts	18 Watts	24 Watts
Luminous Efficacy:	70-80lm/W		70-80lm/W	
Luminous Flux:	420-480lm	840-960lm	1260-1440lm	1680-1920lm
CCT:	3000K / 4000K / 5000K / 6000K		3000K / 4000K / 5000K / 6000K	
CRI:	Ra>80		Ra>80	
Beam Angle:	120°		120°	
IP Rating:	IP20		IP20	
Dimension:	L=120mm * W=120mm * H=38mm	L=170mm * W=170mm * H=38mm	L=225mm * W=225mm * H=38mm	L=300mm * W=300mm * H=38mm
Ceiling Cut-out:	N/A	N/A	N/A	N/A

Dimension Diagram:

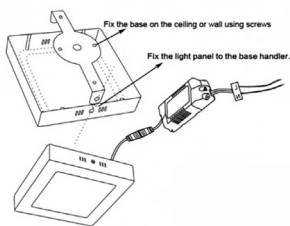
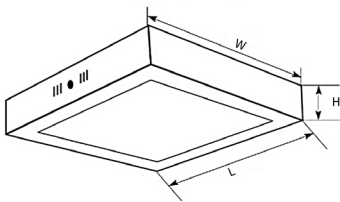

LED Chips:  
**EPISTAR**

Driver:  
**CE RoHS Lifud**

Trim Color:  
 White  
  Black  
  Grey

Photometric Diagram:

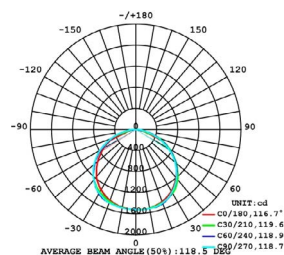

Product Pictures:



Features:

- Recessed, TEE runner mounted
- EPISTAR LED chip
- Lifud or CE approved external driver
- Aluminum heatsink for better heat dissipation
- Frosted PMMA LGP+PS diffuser
- Can be dimmable and CCT tunable

Applications:

- Suitable for ambient or general lighting
- Commercial or Residential use
- Offices, call center, conference room, schools, banks, restaurants etc.

Specifications:

List Price:						
Product:	3012: 1195mm * 295mm		6060: 595mm * 595mm		6012: 1195mm * 595mm	
Model:	BSL-PL-27W-RE-3012	BSL-PL-36W-RE-3012	BSL-PL-27W-SQ-6060	BSL-PL-36W-SQ-6060	BSL-PL-27W-RE-6012	BSL-PL-36W-RE-6012
Input Voltage:	AC100-240V / 50-60Hz		AC100-240V / 50-60Hz		AC100-240V / 50-60Hz	
LED Power:	27 Watts	36 Watts	27 Watts	36 Watts	50 Watts	64 Watts
Luminous Efficacy:	110-120lm/W		110-120lm/W		110-120lm/W	
Luminous Flux:	2970-3240lm	3960-4320lm	2970-3240lm	3960-4320lm	5500-6000lm	7040-7680lm
CCT:	3000K / 4000K / 5000K / 6000K		3000K / 4000K / 5000K / 6000K		3000K / 4000K / 5000K / 6000K	
CRI:	Ra>80		Ra>80		Ra>80	
Beam Angle:	120°		120°		120°	
IP Rating:	IP20		IP20		IP20	
Dimension:	L=1195mm * W=295mm * H=11mm		L=595mm * W=595mm * H=11mm		L=1195mm * W=595mm * H=11mm	
Ceiling Cut-out:	N/A	N/A	N/A	N/A	N/A	N/A

Dimension Diagram:

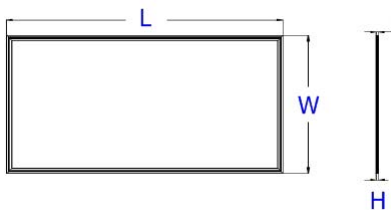
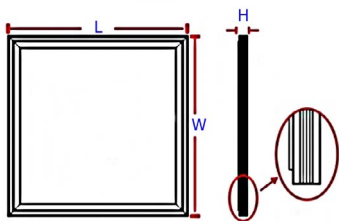

LED Chips:  
**EPISTAR**

Driver:  
CE RoHS  
**Lifud**

Trim Color:  
 White  Black  Grey

Photometric Diagram:

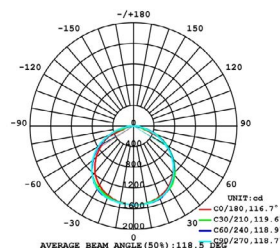

Product Pictures:



Features:

- Integrated Seamless Linkable T5 tube
- High Lumen EPISTAR SMD Chip
- Input AC100-265V/AC100-277
- CE Approved constant current led driver
- High grade aluminum housing
- High purity frosted or clear PC diffuser
- Can be dimmable

Applications:

- Direct replacement for traditional fluorescent tube
- Suitable for ambient or general lighting
- Commercial or Residential use
- Offices, call center, conference room, schools etc.

Specifications:

List Price:						
Lumen/Watt	G5LH: 120-130lm/W			G5LT: 150-160lm/W		
Model:	BSL-T5-9W-60WT-G5LH	BSL-T5-13W-80WT-G5LH	BSL-T5-18W-120WT-G5LH	BSL-T5-9W-60WT-G5LT	BSL-T5-13W-80WT-G5LT	BSL-T5-18W-120WT-G5LT
Input Voltage:	AC100-265V / AC100-277V / 50~60Hz			AC100-265V / AC100-277V / 50~60Hz		
LED Power:	9 Watts	13 Watts	18 Watts	9 Watts	13 Watts	18 Watts
Luminous Efficacy:	120-130lm/W			140-150lm/W		
Luminous Flux:	1080-1170lm	1560-1690lm	2160-2340lm	1350-1440lm	1950-2080lm	2700-2880lm
CCT:	3000K / 4000K / 5000K / 6000K			3000K / 4000K / 5000K / 6000K		
CRI:	Ra>80			Ra>80		
Beam Angle:	120° Clear Cover / 140° Frosted Cover			120° Clear Cover / 140° Frosted Cover		
IP Rating:	IP20			IP20		
Dimension:	L=600mm * W=22mm * H=34mm	L=900mm * W=22mm * H=34mm	L=1200mm * W=22mm * H=34mm	L=600mm * W=22mm * H=34mm	L=900mm * W=22mm * H=34mm	L=1200mm * W=22mm * H=34mm

Dimension Diagram:

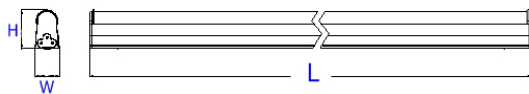

LED Chips:  
**EPISTAR**

Driver:  
**CE RoHS**

Housing Color:  
 White     Black     Grey

Photometric Diagram:

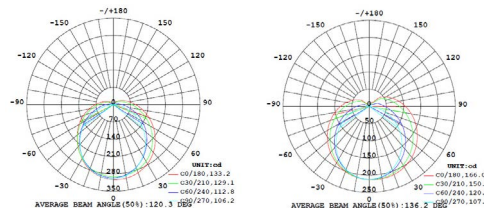



Product Pictures:



Features:

- Replacement for traditional G5 PIN T5 tube
- High Lumen EPISTAR SMD Chip
- Input AC100-265V/AC100-277
- CE Approved constant current led driver
- High grade aluminum housing
- High purity frosted or clear PC diffuser
- Can be dimmable

Applications:

- Direct replacement for traditional fluorescent tube
- Suitable for ambient or general lighting
- Commercial or Residential use
- Offices, call center, conference room, schools etc.

Specifications:

List Price:						
Lm/W:	G5-N: 120-125Lm/W			G5-H: 140-145Lm/W		
Model:	BSL-T5-9W-209-G5-N	BSL-T5-18W-418-G5-N	BSL-T5-25W-425-G5-N	BSL-T5-9W-209-G5-H	BSL-T5-18W-418-G5-H	BSL-T5-25W-425-G5-H
Input Voltage:	AC100-265V / AC100-277V / 50~60Hz			AC100-265V / AC100-277V / 50~60Hz		
LED Power:	9 Watts	18 Watts	25 Watts	9 Watts	18 Watts	25 Watts
Luminous Efficacy:	120-125Lm/W			140-145Lm/W		
Luminous Flux:	1080-1125Lm	2160-2250Lm	3000-3125Lm	1260-1305Lm	2520-2610Lm	3500-3625Lm
CCT:	3000K / 4000K / 5000K / 6000K			3000K / 4000K / 5000K / 6000K		
CRI:	Ra>80			Ra>80		
Beam Angle:	120°			120°		
IP Rating:	IP20			IP20		
PIN Type:	G5			G5		
Dimension:	L=562mm * D=22mm	L=1162mm * D=22mm		L=562mm * D=22mm	L=1162mm * D=22mm	

Dimension Diagram:

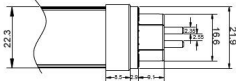
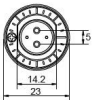
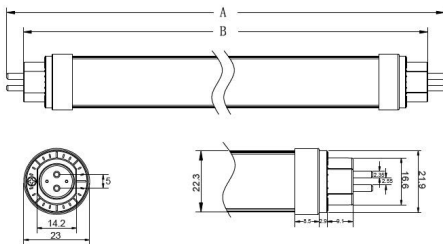

	2feet	3feet	4feet	5feet
Dimension	548	848	1148	1448
A:	562mm	862mm	1162mm	1462mm
B:	548mm	848mm	1148mm	1448mm



LED Chips:  
**EPISTAR**

Driver:  
**CE RoHS**

Housing Color:  
 White  
 Black  
 Grey

Photometric Diagram:

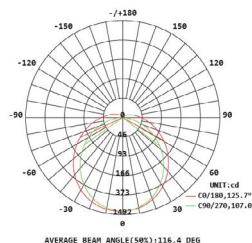

Product Pictures:



Features:

- Replacement for traditional G13 PIN T8 tube
- High Lumen EPISTAR SMD Chip
- Input AC100-240V/AC100-277V/AC100-305V
- CE Approved constant current led driver
- High grade aluminum housing
- High purity frosted or clear PC diffuser
- Can be dimmable

Applications:

- Direct replacement for traditional fluorescent tube
- Suitable for ambient or general lighting
- Commercial or Residential use
- Offices, call center, conference room, schools etc.

Specifications:

List Price:						
Lm/W:	A: 100-110Lm/W		B: 120-130Lm/W		C: 150-160Lm/W	
Model:	BSL-T8-9W-209LT-G8-N	BSL-T8-18W-418LT-G8-N	BSL-T8-9W-209LT-G8-H	BSL-T8-18W-418LT-G8-H	BSL-T8-9W-209LT-G8-T	BSL-T8-18W-418LT-G8-T
Input Voltage:	AC100-240V / AC100-277V / 50-60Hz		AC100-240V / AC100-277V / 50-60Hz		AC100-240V / AC100-277V / 50-60Hz	
LED Power:	9 Watts	18 Watts	9 Watts	18 Watts	9 Watts	18 Watts
Luminous Efficacy:	110-120Lm/W		120-130Lm/W		140-150Lm/W	
Luminous Flux:	900-990Lm	1800-1980Lm	1080-1170Lm	2160-2340Lm	1350-1440Lm	2700-2880Lm
CCT:	3000K / 4000K / 5000K / 6000K		3000K / 4000K / 5000K / 6000K		3000K / 4000K / 5000K / 6000K	
CRI:	Ra>80		Ra>80		Ra>80	
Beam Angle:	120° Clear Cover / 140° Frosted Cover		120° Clear Cover / 140° Frosted Cover		120° Clear Cover / 140° Frosted Cover	
IP Rating:	IP20		IP20		IP20	
PIN Type:	G13		G13		G13	
Dimension:	L=600mm * D=22mm	L=1200mm * D=22mm	L=600mm * D=22mm	L=1200mm * D=22mm	L=600mm * D=22mm	L=1200mm * D=22mm

Dimension Diagram:

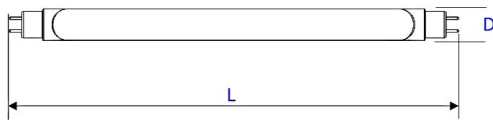

LED Chips:  
**EPISTAR**

Driver:  
CE **RoHS**

Housing Color:  
 White     Black     Grey

Photometric Diagram:

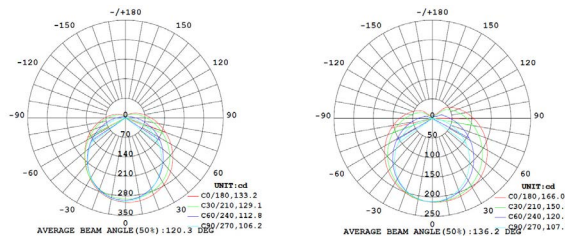

Product Pictures:



Features:

- High Lumen EPISTAR SMD2835 LED Chip
- Linkable connection (optional)
- IP65 / IK08 Tri-proof fixture
- V0 fireproof, high purity frosted or clear PC diffuser
- 6063 aviation grade aluminum PCB and heat sink

Applications:

- Supermarket, engine rooms, basement parking, commissary, food factories, warehouses, farms etc.

Specifications:

List Price:					
Model:	BSH-TPL-20W-ALPHA	BSH-TPL-30W-ALPHA	BSH-TPL-40W-ALPHA	BSH-TPL-50W-ALPHA	BSH-TPL-60W-ALPHA
Input Voltage:	AC220-240V / 50-60Hz			AC220-240V / 50-60Hz	
LED Power:	20 Watts	30 Watts	40 Watts	50 Watts	60 Watts
Luminous Efficacy:	110-120Lm/W			110-120Lm/W	
Luminous Flux:	2200-2400Lm	3300-3600Lm	4400-4800Lm	5500-6000Lm	6600-7200Lm
CCT:	3000K / 4000K / 5000K / 6000K			3000K / 4000K / 5000K / 6000K	
CRI:	Ra>80			Ra>80	
Beam Angle:	120°			120°	
IP Rating:	IP65			IP65	
Dimension:	L=670mm * W=125mm H=95mm	L=670mm * W=125mm H=95mm	L=1270mm * W=125mm H=95mm	L=1270mm * W=125mm H=95mm	L=1570mm * W=125mm H=95mm

Dimension Diagram:

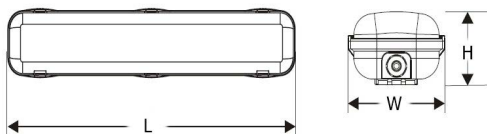

LED Chips:  
**EPISTAR**

Driver:  
**CE RoHS**  
EMC approved

Housing Color:  
 White  Black  Grey

Photometric Diagram:

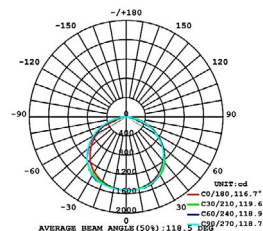

Product Pictures:

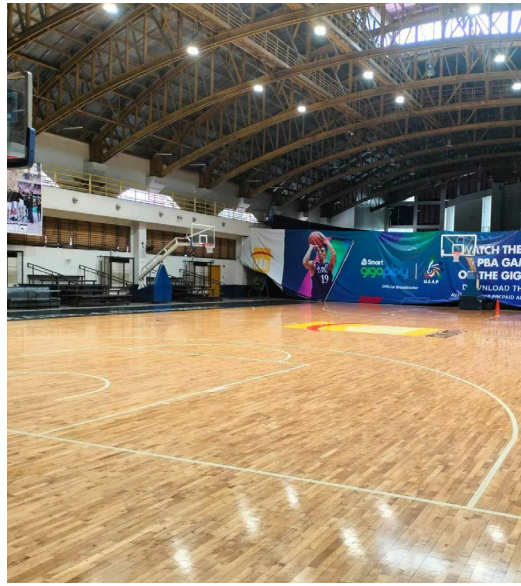

Features:

- Low or high bay applications
- High Lumen LUMILEDS LED chip
- Input AC100-240V/AC100-277V/AC100-305V
- SOSEN or PHILIPS LED driver
- High grade aluminum housing
- High purity clear PC lens cover

Applications:

Suitable for indoor industrial and sports facilities applications like warehouses, factories, gymnasium, exhibition centers, supermarkets etc.

Specifications:

List Price:						
Model:	BSW-HB-80W-H003J	BSW-HB-100W-H003J	BSW-HB-120W-H003J	BSW-HB-150W-H003J	BSW-HB-200W-H003J	BSW-HB-240W-H003J
Input Voltage:	AC200-240V / AC100-277V / 50~60Hz		AC200-240V / AC100-277V / 50~60Hz		AC200-240V / AC100-277V / 50~60Hz	
LED Power:	80 Watts	100 Watts	120 Watts	150 Watts	200 Watts	240 Watts
Luminous Efficacy:	150-160Lm/W		150-160Lm/W		150-160Lm/W	
Luminous Flux:	12000-12800Lm	15000-16000Lm	18000-19200Lm	22500-24000Lm	30000-32000Lm	36000-38400Lm
CCT:	3000K / 4000K / 5000K / 6000K		3000K / 4000K / 5000K / 6000K		3000K / 4000K / 5000K / 6000K	
CRI:	Ra>80		Ra>80		Ra>80	
Beam Angle:	120° / 90° / 60°		120° / 90° / 60°		120° / 90° / 60°	
IP Rating:	IP65		IP65		IP65	
Mounting Type:	Pendant		Pendant		Pendant	
Dimension:	D=254mm * H=160mm	D=254mm * H=160mm	D=309mm * H=166mm	D=309mm * H=166mm	D=354mm * H=171mm	D=354mm * H=171mm

Dimension Diagram:

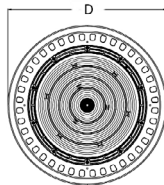
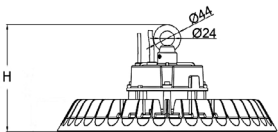

LED Chips:



Driver:



Housing Color:



Photometric Diagram:

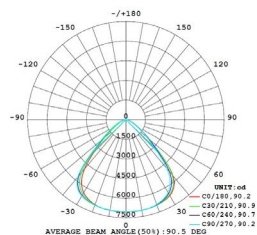



Product Pictures:

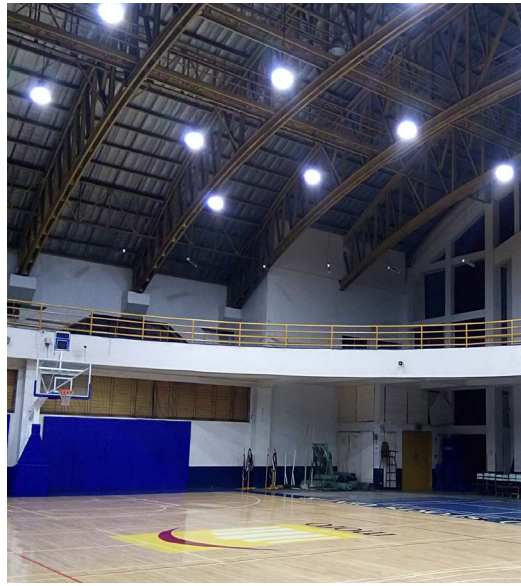

Features:

- Low or high bay applications
- High Lumen LUMILEDS LED chip
- Input AC100-240V/AC100-277V/AC100-305V
- SOSEN or PHILIPS LED driver
- High grade aluminum housing
- High purity clear PC lens cover

Applications:

Suitable for indoor industrial and sports facilities applications like warehouses, factories, gymnasium, exhibition centers, supermarkets etc.

Specifications:

List Price:						
Model:	BSW-HB-80W-H003F	BSW-HB-100W-H003F	BSW-HB-120W-H003F	BSW-HB-150W-H003F	BSW-HB-200W-H003F	BSW-HB-240W-H003F
Input Voltage:	AC200-240V / AC100-277V / 50~60Hz		AC200-240V / AC100-277V / 50~60Hz		AC200-240V / AC100-277V / 50~60Hz	
LED Power:	80 Watts	100 Watts	120 Watts	150 Watts	200 Watts	240 Watts
Luminous Efficacy:	180-190Lm/W		180-190Lm/W		180-190Lm/W	
Luminous Flux:	14400-15200Lm	18000-19000Lm	21600-22800Lm	27000-28500Lm	36000-38000Lm	43200-45600Lm
CCT:	3000K / 4000K / 5000K / 6000K		3000K / 4000K / 5000K / 6000K		3000K / 4000K / 5000K / 6000K	
CRI:	Ra>80		Ra>80		Ra>80	
Beam Angle:	120° / 90° / 60°		120° / 90° / 60°		120° / 90° / 60°	
IP Rating:	IP65		IP65		IP65	
Mounting Type:	Pendant		Pendant		Pendant	
Dimension:	D=254mm * H=160mm	D=254mm * H=160mm	D=309mm * H=166mm	D=309mm * H=166mm	D=354mm * H=171mm	D=354mm * H=171mm

Dimension Diagram:

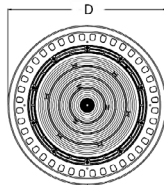
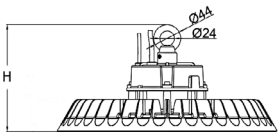

LED Chips:



Driver:



Housing Color:



Photometric Diagram:

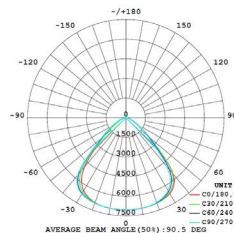

Product Pictures:

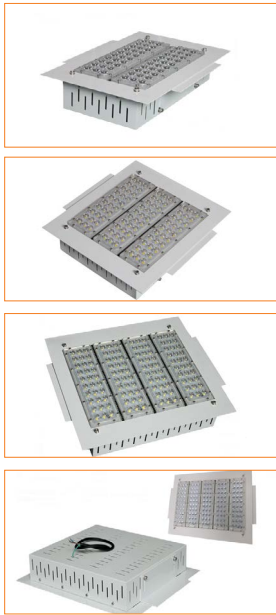

Features:

- LUMILEDS (PHILIPS) LED chip
- MEANWELL or SOSEN LED driver
- AC100-277V/AC100-305V input voltage
- Recess mounted fixture
- High grade aluminum housing
- High purity clear PC lens cover

Applications:

Gas stations, toll plaza, petrochemical warehouses or buildings, chemical factories, oil depot etc.

Specifications:

List Price:				
Model:	BSW-GS-100W-CP001	BSW-GS-150W-CP001	BSW-GS-200W-CP001	BSW-GS-240W-CP001
Input Voltage:	AC100-277V / 50-60Hz		AC100-277V / 50-60Hz	
LED Power:	100 Watts	150 Watts	200 Watts	240 Watts
Luminous Efficacy:	150-160Lm/W		150-160Lm/W	
Luminous Flux:	15000-16000Lm	22500-24000Lm	30000-32000Lm	36000-38400Lm
CCT:	3000K / 4000K / 5000K / 6000K		3000K / 4000K / 5000K / 6000K	
CRI:	Ra>80		Ra>80	
Beam Angle:	90° / 60°		90° / 60°	
IP Rating:	IP65		IP65	
Mounting Type:	Recess		Recess	
Dimension:	L=229mm * W=350mm * H=72mm	L=311mm * W=350mm * H=72mm	L=393mm * W=350mm * H=72mm	L=507mm * W=350mm * H=72mm

Dimension Diagram:

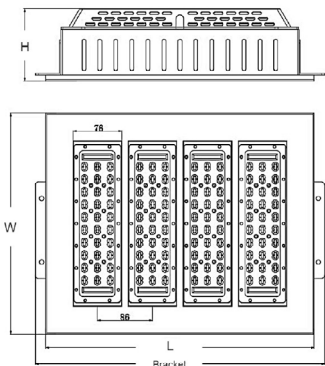

LED Chips:



Driver:



Housing Color:



Photometric Diagram:

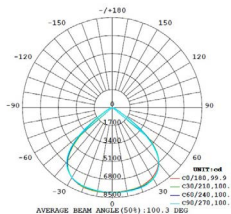

- 
- High quality products
  - Excellent customer care
  - Good value for money
- 

We will continue...

To provide energy-efficient, environment-friendly lighting products & renewable energy. Sourced from a select group of suppliers that adheres to international standards of quality.

---

**KASSEL Ventures Phils., Inc.**

Unit 519 5th Floor, Cityland Shaw Tower, Shaw Boulevard  
Mandaluyong City 1552, Philippines  
Tel. Nos.: +632-8633-6610; +632-8470-6669  
Email: sales@brightluxled.com.ph; brightluxledsales@gmail.com  
Website: www.brightlux-led.co